

EX-STOCK AUSTRALIA

Amphenol

Amphenol Australia

Now you're connected!

# eco | mate® & C16-3 PRODUCT SHORTFORM

Amphenol Australia Pty Ltd

**Quick Facts:**

- ecomate circular threaded coupling connectors available in 3+PE and 6+PE, complete with clamping ring or internal strain relief

- C16-3 circular bayonet coupling connectors available in 5+PE complete with internal strain relief

- ecomate 3+PE, offers a screw type termination rated to 16A @ 400VAC

- ecomate 6+PE, offers a solder type termination rated to 10A @ 250VAC, or a crimp type termination rated to 13A @ 250VAC

- C16-3 5+PE, offers a screw type termination rated to 21A @ 400VAC

- ecomate boasts an IP65/67 protection class rating in mated condition

- C16-3 boasts an IP65 protection class rating in mated condition

- Housing components made from premium Polyamide 6.6 molding material









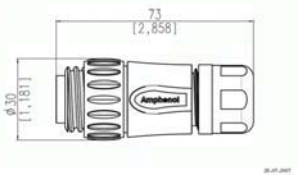

- Mechanical durability of 500 Mating cycles

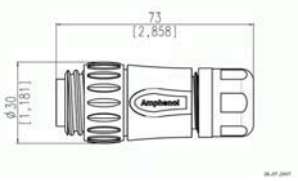

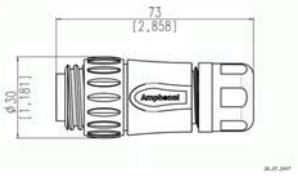
# Amphenol Australia

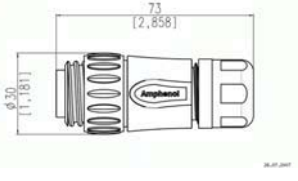
## eco | mate®

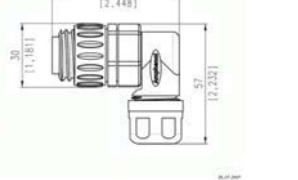

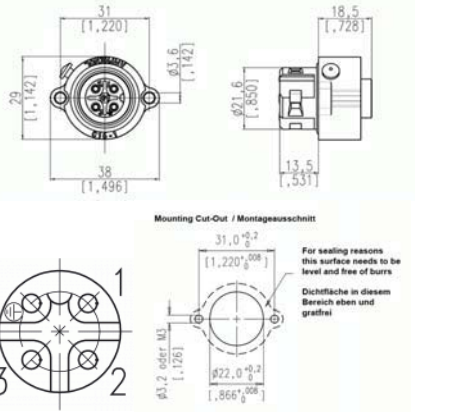





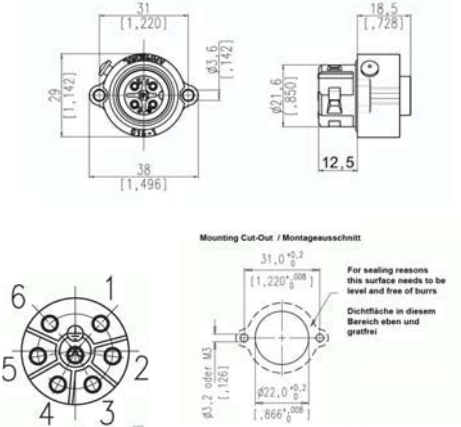

### ecomate 3+PE & 6+PE

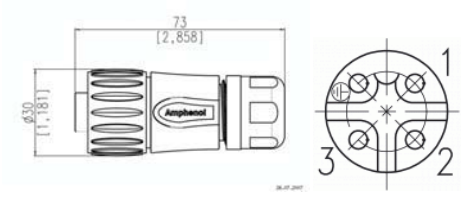
PRODUCT – FIGURE	DRAWING	DESCRIPTION	PART NUMBER
		MALE straight cable connector, with internal strain relief, screw termination, blue back shell, 3+PE	C016 20H003 110 10
		MALE straight cable connector, with internal strain relief, screw termination, black back shell, 3+PE	C016 20H003 110 12
		MALE straight cable connector, with internal strain relief, solder termination, black back shell, 6+PE	C016 30H006 110 12
		MALE straight cable connector, strain relief with clamping ring, crimp termination, black back shell, 6+PE	C016 10H006 000 12
		MALE right angled cable connector, strain relief with clamping ring, solder termination, black back shell, 6+PE	C016 30K006 100 12
		FEMALE receptacle, screw termination, black, 3+PE	C016 20G003 100 12

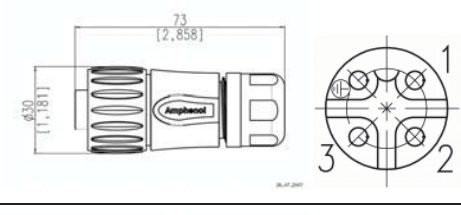
# Amphenol Australia

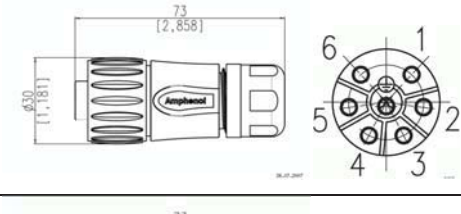

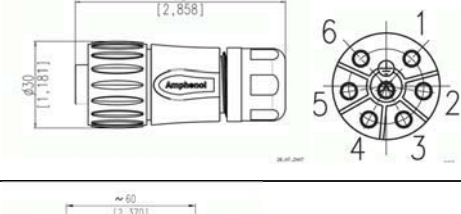

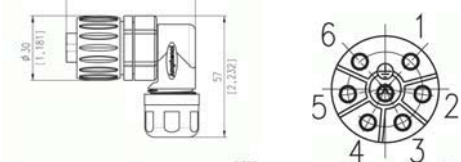
## eco | mate®

ecomate 3+PE & 6+PE continued....

PRODUCT - FIGURE	DRAWING	DESCRIPTION	PART NUMBER
		<b>FEMALE</b> receptacle, solder termination, black, 6+PE	C016 30G006 100 12
		<b>FEMALE</b> straight cable connector, with internal strain relief, screw termination, blue back shell, 3+PE	C016 20D003 110 10
		<b>FEMALE</b> straight cable connector, with internal strain relief, screw termination, black back shell, 3+PE	C016 20D003 110 12
		<b>FEMALE</b> straight cable connector, with internal strain relief, solder termination, black back shell, 6+PE	C016 30D006 110 12
		<b>FEMALE</b> straight cable connector, strain relief with clamping ring, crimp termination, black back shell, 6+PE	C016 10D006 000 12
		<b>FEMALE</b> right angled cable connector, strain relief with clamping ring, solder, black back shell, 6+PE	C016 30F006 100 12

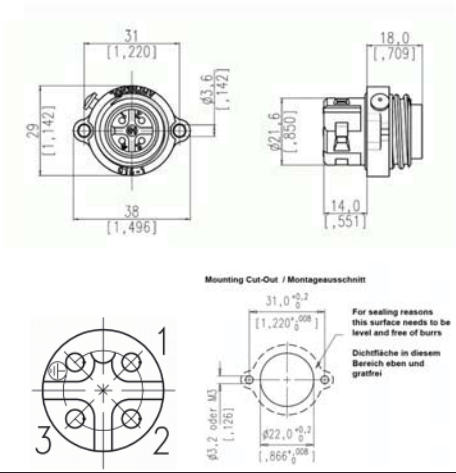
## eco | mate®

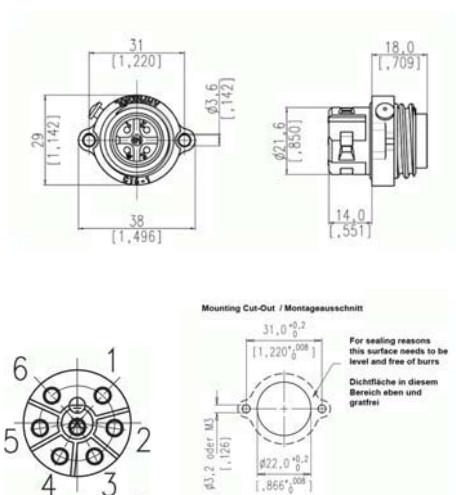

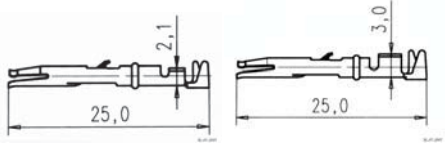



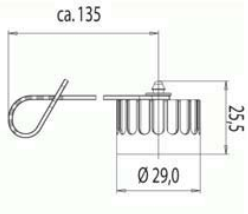

ecomate 3+PE & 6+PE continued....

PRODUCT – FIGURE	DRAWING	DESCRIPTION	PART NUMBER
		<p><b>MALE receptacle, screw termination, black, 3+PE</b></p>	<p><b>C016 20C003 100 12</b></p>
		<p><b>MALE receptacle, solder termination, black, 6+PE</b></p>	<p><b>C016 30C006 100 12</b></p>
		<p><b>PIN CONTACT (Pack of 100pcs) Wire gauge: 0.14 - 0.5mm<sup>2</sup> (Silver Plated)</b></p>	<p><b>VN 01 016 0011 (1)</b></p>
		<p><b>0.5 to 1.5mm<sup>2</sup> (Silver Plated)</b></p>	<p><b>VN 01 016 0004 (1)</b></p>
		<p><b>0.5 to 1.5mm<sup>2</sup> (Gold Plated)</b></p>	<p><b>VN 01 016 0004 (2)</b></p>
		<p><b>SOCKET CONTACT (Pack of 100pcs) Wire gauge: 0.14 - 0.5mm<sup>2</sup> (Silver Plated)</b></p>	<p><b>VN 02 016 0003 (1)</b></p>
		<p><b>0.5 to 1.5mm<sup>2</sup> (Silver Plated)</b></p>	<p><b>VN 02 016 0002 (1)</b></p>
		<p><b>0.5 to 1.5mm<sup>2</sup> (Gold Plated)</b></p>	<p><b>VN 02 016 0002 (2)</b></p>

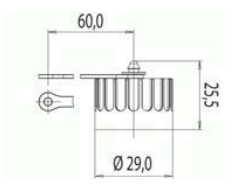
# Amphenol Australia

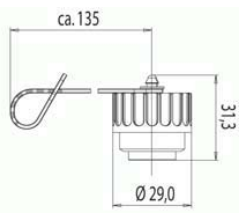
## eco | mate®

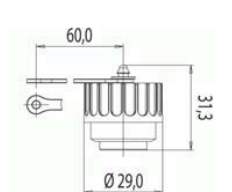







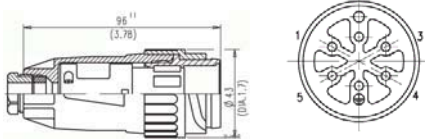

ecomate 3+PE & 6+PE continued....

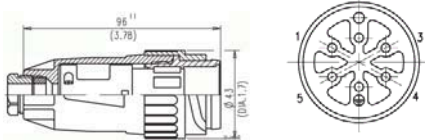
PRODUCT – FIGURE	DRAWING	DESCRIPTION	PART NUMBER
		<b>PROTECTIVE COVER</b> for male cable connector	<b>C016 00U000 010 12</b>
		<b>PROTECTIVE COVER</b> for male receptacle	<b>C016 00U000 000 12</b>
		<b>PROTECTIVE COVER</b> for female cable connector	<b>C016 00V000 010 12</b>
		<b>PROTECTIVE COVER</b> for female receptacle	<b>C016 00V000 000 12</b>
		<b>HAND CRIMPING TOOL</b>	<b>TA 0100 146</b>
		<b>FRONT RELEASE REMOVAL TOOL</b> for use with ecomate contacts: .N01 016 0011(.) .N01 016 0004(.) .N02 016 0003(.) .N02 016 0002(.)	<b>FG 0300 146 1</b>

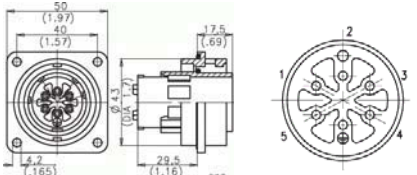
# Amphenol Australia

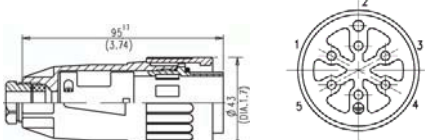
## C16-3

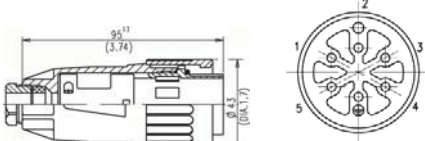

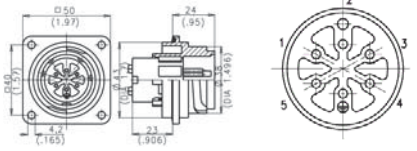
### C16-3 5+PE

PRODUCT – FIGURE	DRAWING	DESCRIPTION	PART NUMBER
		<b>MALE</b> straight cable connector, shell size 2, long style I with internal strain relief, 12-14mm <sup>2</sup> cable outlet, screw termination, 5+PE	C016 20I005 103 2
		<b>MALE</b> straight cable connector, shell size 2, long style I with internal strain relief, 14-16mm <sup>2</sup> cable outlet, screw termination, 5+PE	C016 20I005 104 2
		<b>FEMALE</b> receptacle, shell size 2, style G, screw termination, 5+PE	C016 20G005 100 2
		<b>FEMALE</b> straight cable connector, shell size 2, long style E with internal strain relief, 12-14mm <sup>2</sup> cable outlet, screw termination, 5+PE	C016 20E005 103 2
		<b>FEMALE</b> straight cable connector, shell size 2, long style E with internal strain relief, 14-16mm <sup>2</sup> cable outlet, screw termination, 5+PE	C016 20E005 104 2
		<b>MALE</b> receptacle, shell size 2, style C, screw termination, 5+PE	C016 20C005 100 2

# Amphenol Australia

## C16-3

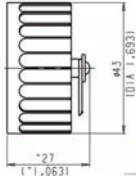
C16-3 5+PE continued....

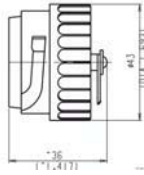
PRODUCT – FIGURE	DRAWING	DESCRIPTION	PART NUMBER
		PROTECTIVE COVER for male receptacle	C016 00U000 000 2
		PROTECTIVE COVER for female cable connector	C016 00V000 010 2

Other options available (but not stocked at Amphenol Australia) include:

	C 16-3 Shell Size 2 12+PE		C 16-3 Shell Size 1 8+PE
	C 16-3 Shell Size 2 14+PE		C 16-3 Shell Size 1 14+PE
	C 16-3 Shell Size 2 19+PE		C 16-3 Shell Size 1 12+3+PE
	C 16-3 Shell Size 1 2+PE		C 16-3 Shell Size 1 17+PE
	C 16-3 Shell Size 1 3+PE		C 16-L Shell Size 2 4+PE